

**CASTLE** Series  
1-3K

USER MANUAL

 **SANTAK**



**Thank you for selecting a SANTAK product to protect your electrical equipment.**

**This manual contains important instructions that you should follow during installation and maintenance of the UPS and batteries. Please read all instructions before operating the equipment and save this manual for future reference.**

## Safety and EMC Instructions

**Please read carefully the following user manual and the safety instructions before installing or operating the unit!**

### Installation

- ★ See installation instructions before connecting to mains power.
- ★ Condensation may occur if the UPS is moving directly from a cold to a warm environment. The UPS must be absolutely dry before being installation. It is recommended to have an acclimatization time at least two hours.
- ★ Do not install the UPS near water or in damp environment.
- ★ Do not install the UPS where it would be exposed to direct sunlight or near heat.
- ★ Do not connect appliances or items of equipment which would overload the UPS (e.g. laser printers, etc.) to the UPS output.
- ★ Place cables properly to avoid someone treaded or tripped over them.
- ★ Assure to connect with the earth reliably.
- ★ Connect the UPS only to a socket outlet which is earthed shockproof type.
- ★ The building wiring socket outlet (shockproof socket outlet) must be easily accessible to close to the UPS.
- ★ With the installation of the equipment, the sum of the leakage current of the UPS and the connected load does not exceed 3.5mA.
- ★ Do not block ventilation openings on the UPS's housing. Ensure the air vents on the front, side and rear of the UPS are not blocked. Recommended at least 25cm of space on each side. The air flow diagram is shown as below:

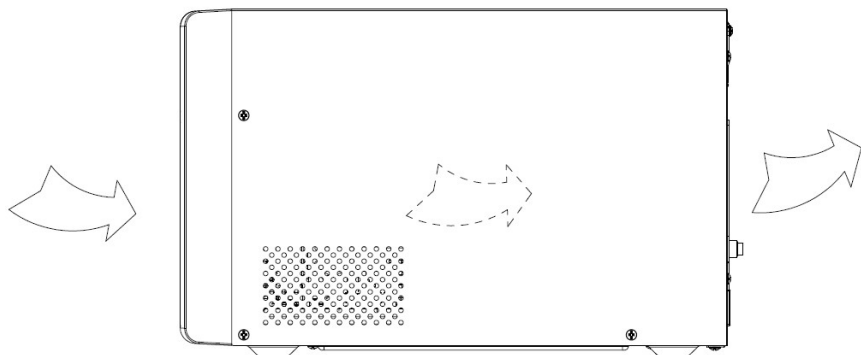

■ **Figure The Air Flow Diagram**

- ★ This UPS receives power from more than one source-disconnection of AC source and the DC source is required to de-energize this unit before servicing.
- ★ An additional circuit breaker or fuse with rating 16A and breaking capacity 3kA shall be used between power source and input when installation this unit.

## Operation

- ★ For safety consideration, do not disconnect the mains cable on the UPS or the building wiring socket (grounded shockproof socket) during operation, the grounding for the UPS and all loads connected will be disconnected.
- ★ The UPS features its own, internal current source (batteries). You may be electric shocked when you touch the UPS output sockets or output terminal block even if the UPS is not connected to the building wiring socket.
- ★ In order to fully disconnect the UPS, first press the OFF button to turn off the UPS, and then disconnect the mains lead.
- ★ Ensure that no liquid or other external objects can enter the UPS.
- ★ Do not remove the enclosure. This system is to be serviced by

qualified service person only. There are NO USER SERVICEABLE PARTS inside the UPS.

- ★ Remove the protective panel only after disconnecting the terminal connections.

## **Maintenance, servicing and faults**

- ★ The UPS operates with hazardous voltages. Repairs may be carried out only by qualified service person.
- ★ Caution - risk of electric shock. Even after the unit is disconnected from the mains power supply (building wiring socket), components inside the UPS are still connected to the battery which are potentially dangerous.
- ★ Before carrying out any kind of service and/or maintenance, disconnect the batteries. Verify that no current is present and no hazardous voltage exists in the capacitor or BUS capacitor terminals.
- ★ Batteries must be replaced only by qualified person.
- ★ Caution - risk of electric shock. The battery circuit is not isolated from the input voltage. Hazardous voltages may occur between the battery terminals and the ground. Verify that no voltage is present before servicing!
- ★ Batteries have a high short-circuited current and pose a risk of shock. Take all precautionary measures specified below and any other measures necessary when working with batteries:
  - remove all jewellery, wristwatches, rings and other metal objects
  - use only tools with insulated grips and handles.
  - Wear rubber gloves and boots.
  - Do not lay tools or metal parts on top of batteries.
  - Disconnect the charging source prior to connecting or disconnecting battery terminals.
- ★ When changing batteries, replace with the same quantity and the same type of batteries.

- ★ Do not attempt to dispose of batteries by burning them. It could cause explosion.
- ★ Do not open or destroy batteries. Effluent electrolyte can cause injury to the skin and eyes. It may be toxic.
- ★ Please replace the fuse only by a fuse of the same type and of the same amperage in order to avoid fire hazards.
- ★ Do not dismantle the UPS, except the qualified service person.

## Transport

- ★ Please transport the UPS only in the original packaging (to protect against shock and impact).

## Storage











- ★ The UPS must be stockpiled in the room where it is ventilated and dry.

## Standards

<b>* Safety</b>	
IEC/EN 62040-1	
<b>* EMI</b>	
Conducted Emission.....:IEC/EN 62040-2	Category C2
Radiated Emission.....:IEC/EN 62040-2	Category C2
Harmonic Current.....:IEC/EN 61000-3-2	
Voltage Fluctuation and Flicker.....:IEC/EN 61000-3-3	
<b>*EMS</b>	
ESD.....:IEC/EN 61000-4-2	Level 3
RS.....:IEC/EN 61000-4-3	Level 3
EFT.....:IEC/EN 61000-4-4	Level 4
SURGE.....:IEC/EN 61000-4-5	Level 4
CS.....:IEC/EN 61000-4-6	Level 3
MS.....: IEC/EN 61000-4-8	Level 4
Voltage Dips.....: IEC/EN 61000-4-11	
Low Frequency Signals.....:IEC/EN 61000-2-2	

## Description of Commonly Used Symbols

Some or all of the following symbols may be used in this manual. It is advisable to familiarize yourself with them and understand their meaning:

Symbol and Explanation			
Symbol	Explanation	Symbol	Explanation
	Alert you to pay special attention		Alternating current source (AC)
	Caution of high voltage		Direct current source (DC)
	Turn on the UPS		Protective ground
	Turn off the UPS		Recycle
	Idle or shut down the UPS		Do not dispose with ordinary trash



# CONTENT

<b>1. INTRODUCTION .....</b>	<b>1</b>
<b>2. PANEL DESCRIPTION .....</b>	<b>3</b>
2.1 BUTTON .....	3
2.2 LCD DESCRIPTION.....	4
<b>3. CONNECTION AND OPERATION.....</b>	<b>8</b>
3.1 INSPECTION: .....	8
3.2 CONNECTION: .....	8
3.3 BATTERY RECHARGE:.....	11
3.4 TURN ON THE UPS: .....	11
3.5 TEST FUNCTION:.....	11
3.6 TURN OFF THE UPS:.....	12
3.7 AUDIBLE ALARM MUTE FUNCTION: .....	12
<b>4. OPERATING MODE.....</b>	<b>13</b>
4.1 ONLINE MODE .....	13
4.2 BAT. MODE .....	14
4.3 BYPASS MODE.....	15
4.4 NO OUTPUT MODE.....	16
4.5 ECO MODE (ECONOMY MODE) .....	16
4.6 CVCF MODE .....	16
<b>5. TROUBLE SHOOTING .....</b>	<b>18</b>
<b>6. MAINTENANCE .....</b>	<b>21</b>
6.1 OPERATION .....	21
6.2 STORAGE.....	21
<b>7. TECHNICAL DATA.....</b>	<b>22</b>
7.1 ELECTRICAL SPECIFICATIONS .....	22
7.2 OPERATING ENVIRONMENT .....	22
7.3 TYPICAL BACKUP TIME (TYPICAL VALUES AT 25°C IN MINUTES : ).....	23
7.4 DIMENSIONS AND WEIGHTS .....	23
<b>8. COMMUNICATION PORT.....</b>	<b>24</b>
8.1 RS-232 COMMUNICATION PORTS.....	24
8.2 AS400 INTERFACE (OPTIONAL).....	24
8.3 CMC INTERFACE (OPTIONAL) .....	24
8.4 NMC INTERFACE (OPTIONAL) .....	24
8.5 SOFTWARE.....	24
<b>APPENDIX : REAR PANEL.....</b>	<b>26</b>

# 1. Introduction

The Castle on-line Series is an uninterruptible power supply incorporating double-converter technology. It provides perfect protection specifically for Linux, UNIX, and Windows servers.

The double-converter principle eliminates all mains power disturbances. A rectifier converts the alternating current from the socket outlet to direct current. This direct current charges the batteries and powers the inverter. On the basis of this DC voltage, the inverter generates a sinusoidal AC voltage, which permanently supplies the loads.

Computers and periphery are thus powered entirely by the mains voltage. In the event of power failure, the maintenance-free batteries power the inverter.

This manual covers the UPS listed as follows. Please confirm whether it is the model you intend to purchase by performing a visual inspection of the Model No. on the rear panel of the UPS.

## The Model List

Item	Model name	Power Rating	Model type	Model description	Other
1	Castle 1K	1000VA/ 900W	Tower	Standard model	Single Phase input Single Phase Output
2	Castle 1KS	1000VA/ 900W	Tower	Long Backup time model	Single Phase input Single Phase Output
3	Castle 2K	2000VA/ 1800W	Tower	Standard model	Single Phase input Single Phase Output
4	Castle 2KS	2000VA/ 1800W	Tower	Long Backup time model	Single Phase input Single Phase Output
5	Castle 3K	3000VA/ 2700W	Tower	Standard model	Single Phase input Single Phase Output
6	Castle 3KS	3000VA/ 2700W	Tower	Long Backup time model	Single Phase input Single Phase Output

## UPS Block Diagram

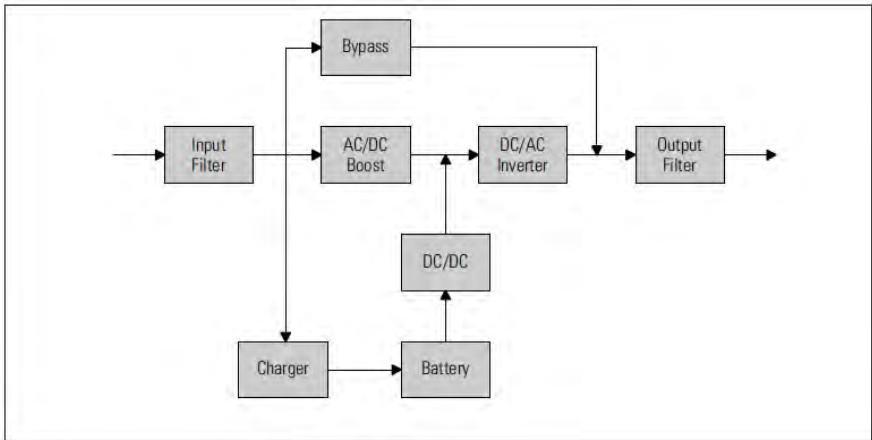

## 2. Panel Description

The display panel of 1K/1KS/2K/2KS/3K/3KS is the same, which is shown as below:

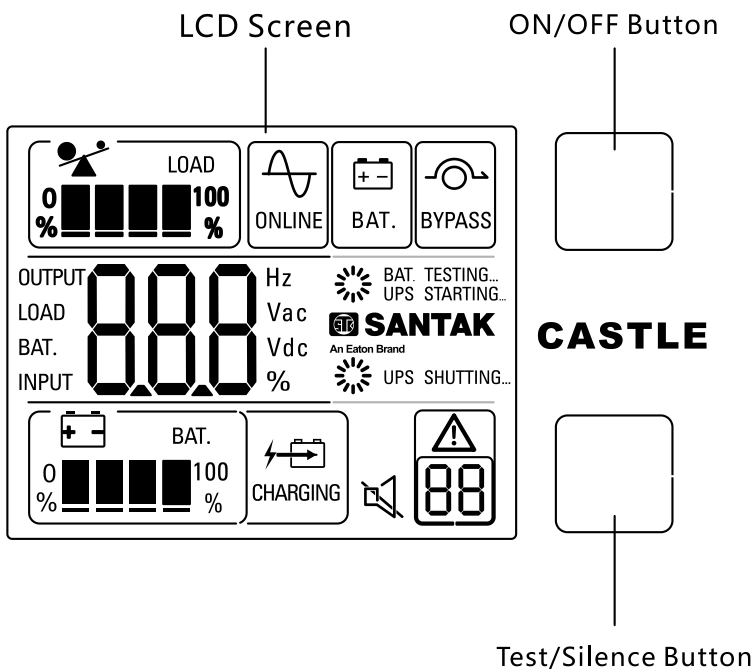

■ Figure 2.1 The Display Panel

### 2.1 Button

Switch	Function
<b>ON/OFF Button</b>	<ol style="list-style-type: none"> <li>1. By pressing the button continuously for more than 500ms the UPS system is turned on.</li> <li>2. When mains power is normal, by pressing the button continuously for more than 500ms the UPS system switches to no output or Bypass mode, and the inverter is off. At this moment, if Bypass is enabled, then the output sockets are supplied with voltage via the bypass if the mains power is available.</li> <li>3. Release the UPS from fault mode. Fault mode released: After the fault occurs, the UPS will shut down the inverter output to enter the failure mode, press the button for more than 500ms</li> </ol>





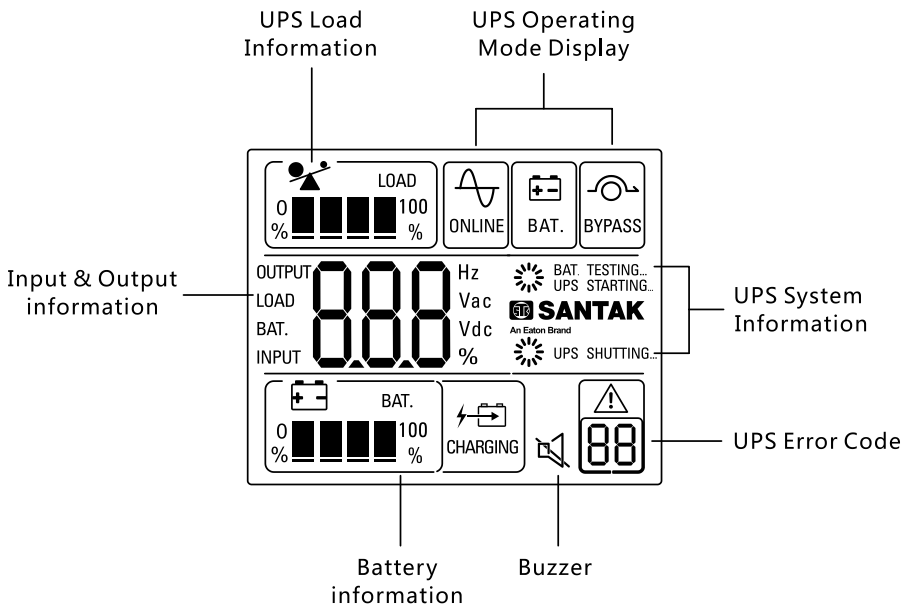









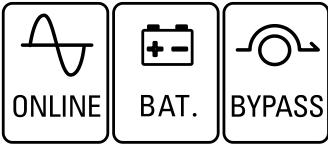
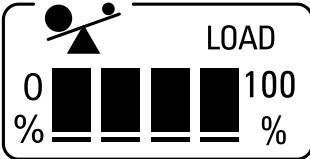



	<p>(effective sound prompt), failure to remove, UPS into bypass mode or Standby mode (whether bypass output depends on the bypass condition).</p> <p>Note: Short-circuit fault needs to be cut off after the mains input can be lifted.</p>
<b>Test/Silence Button</b>	<p>1. ONLINE and ECO mode Press the key for more than 4s, the UPS will enter the battery self-test mode, and the battery self-test mode will automatically detect whether the battery is connected normally or whether the battery voltage is low. After this the UPS will return to ONLINE mode .</p> <p>2. The key pressing for more than 2s and less than 4s, the UPS can quiet the current alarm sound (including battery mode or bypass mode). Press this button again for more than 2s and less than 4s. Mute is released and the buzzer returns to normal.</p> <p>Note: the buzzer is only the sound of the current alarm, the buzzer will re-beep when a new alarm appears.</p> <p>3. Press the button for more than 100ms less than 500ms to switch the page .</p>









## 2.2 LCD description

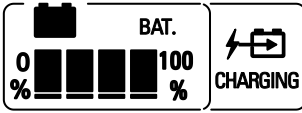

■ Figure 2.2 The LCD Display

## LCD icon Function



Display	Function										
<b>Input &amp; Output Information</b>											
OUTPUT  Hz LOAD  Vac BAT.  Vdc INPUT  %	It indicates input & output voltage/frequency value, which are displayed alternately. It also indicate load per cent and battery voltage value .										
<b>UPS Operating Mode Display</b>											
	It indicates UPS operating mode .										
<b>Load Information</b>											
	It indicates the load level. Every grid represents the level of 25%. If UPS is overloaded , the icon  would flash once time per second . <table border="1" data-bbox="479 1145 996 1364"> <thead> <tr> <th>Grid</th> <th>Actual Load</th> </tr> </thead> <tbody> <tr> <td> 100%</td> <td>0%~25%</td> </tr> <tr> <td> 100%</td> <td>26%~50%</td> </tr> <tr> <td> 100%</td> <td>51%~75%</td> </tr> <tr> <td> 100%</td> <td>≥76%</td> </tr> </tbody> </table>	Grid	Actual Load	 100%	0%~25%	 100%	26%~50%	 100%	51%~75%	 100%	≥76%
Grid	Actual Load										
 100%	0%~25%										
 100%	26%~50%										
 100%	51%~75%										
 100%	≥76%										

Battery Information											
	<p>It indicates the battery capacity. Every grid represents the capacity of 20%. If the battery charger is running, the icon  CHARGING would show.</p> <table border="1" data-bbox="481 311 991 518"> <thead> <tr> <th>Grid</th> <th>Actual Capacity</th> </tr> </thead> <tbody> <tr> <td>0 █ 100 %</td> <td>0%~25%</td> </tr> <tr> <td>0 █ █ 100 %</td> <td>26%~50%</td> </tr> <tr> <td>0 █ █ █ 100 %</td> <td>51%~75%</td> </tr> <tr> <td>0 █ █ █ █ 100 %</td> <td>≥76%</td> </tr> </tbody> </table>	Grid	Actual Capacity	0 █ 100 %	0%~25%	0 █ █ 100 %	26%~50%	0 █ █ █ 100 %	51%~75%	0 █ █ █ █ 100 %	≥76%
Grid	Actual Capacity										
0 █ 100 %	0%~25%										
0 █ █ 100 %	26%~50%										
0 █ █ █ 100 %	51%~75%										
0 █ █ █ █ 100 %	≥76%										
Buzzer											
	<p>The icon will be displayed after panel key operation or serial command mute</p>										
	<p>The icon will be displayed when the buzzer sounds normally.</p>										
Else											
	<p>It indicates the UPS is in Fault mode or has some warnings. It Indicates Fault kind or Warning kind, several warning kinds at the same time could be displayed alternately.</p> <p>The icon  would flash when having warnings. The icon  would show continuous when in Fault mode.</p>										
	<p>It indicates UPS Brand Logo and UPS system information.</p>										

### Operating Mode

The different UPS Operating Mode would be displayed on the LCD screen corresponding to their operating modes, and they are illustrated as the

following table.

Normal Operation Mode	 ONLINE	 BAT.	 BYPASS
No Output Mode	○	○	○
Bypass Output Mode	○	○	●
ONLINE/Converter Output Mode	●	○	○
Battery/Battery Test Mode	●	●	○
ECO Mode	●	○	●

●:Icon display

○:Icon no display



### 3. Connection and Operation

The system may be installed and wired only by qualified electricians in accordance with applicable safety regulations!

When installing the electrical wiring, please note the nominal amperage of your incoming feeder.

#### 3.1 Inspection:

Inspect the packaging carton and its contents for damage. Please inform the transport agency immediately if you find signs of damage. Please keep the packaging in a safe place for future use.

**Note: To avoid any safety issue, please ensure that the incoming feeder (mains) is isolated completely while whole installing process.**

#### 3.2 Connection:

##### (1) UPS Input Connection

If the UPS is connected via the power cord, please use a proper socket with protection against electric current, and pay attention to the capacity of the socket. The UPS System has an input breaker on the standard cabinet.

##### (2) UPS Output Connection

The output sockets and types of the UPS are shown below:

Model No.	Output Socket -IEC(pcs)
Castle 1K	4*C13
Castle 1KS	3*C13

Castle 2K	4*C13
Castle 2KS	6*C13
Castle 3K	4*C13+1*C19
Castle 3KS	3*C13+Terminal block

For 3KS model, Connect the output and ground wires to the terminal block according to Figure 5.1 and the table 5.1

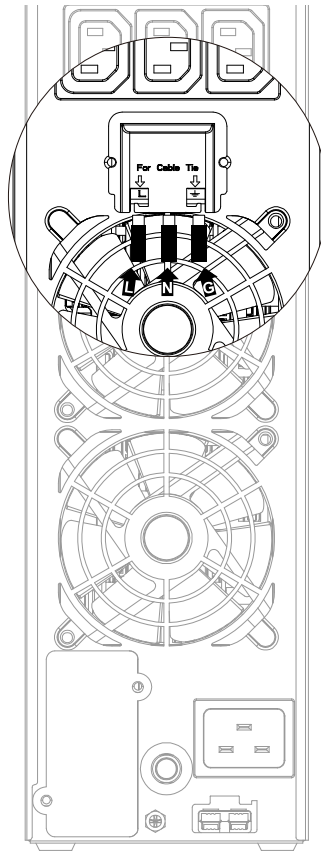

■ Figure 3.1 Output Connection diagram of 3KS model

**Table 3.1**

Terminal position	Wire function	Terminal wire size rating	Tightening torque
L	Line Out	1.5mm <sup>2</sup> -2.5mm <sup>2</sup> (14AWG-12AWG )	0.5Nm(4.4 Lb In)
N	Neutral Out		
	Output Ground		

### (3) Battery Input Connection for long backup time model

When connecting the external batteries it's recommended to pay attention to these following items:

- ★ Use the battery pack with voltage:

24VDC for Castle 1KS, (2 pcs of 12V batteries),

48VDC for Castle 2KS, (4 pcs of 12V batteries),

72VDC for Castle 3KS, (6 pcs of 12V batteries)

Note: Connection of batteries more than or less than required will cause abnormality or permanent damage.

- ★ One Standard type battery connector on the rear panel is used for connecting the battery pack.
- ★ The battery connection procedure is very important. Any incompliance may result in the risk of electric shock. Therefore, the following steps must be strictly complied with.
- ★ Prepare the battery cable with Standard type connector which should be able to carry the current.
- ★ If there is a battery breaker then turn it off first. Then connect the battery cable to the Standard type battery connector on the rear panel.
- ★ Connect the input power cord of the UPS to mains power supply, the battery would start to be charged.

**The Caution!**

A DC breaker must be connected between the UPS and external battery .

**The Caution!**

The output sockets of the UPS system may still be electrically live even if the power supply system has been disconnected.

### 3.3 Battery recharge:

Fully charge the batteries (external) of the UPS system by leaving the UPS system connected to the mains power for 1-2 hours approximately. The UPS system is able to operate directly without recharging process, but the backup time may be shorter than the nominal value specified.

### 3.4 Turn on the UPS:

**(1) With mains power connecting:**

Press On/OFF-button continuously for more than 500ms to turn on the UPS, the UPS will get into the ONLINE mode; the LCD screen will indicate the state of the UPS.

**(2) Without mains power connecting:**

Even though mains power is not connected to the UPS, the UPS still can be turned on by just simply pressing ON/OFF button continuously for more than 500ms with external batteries connected, the UPS will get into the Battery mode, and the LCD screen will indicate the state of the UPS.

***Note: The default setting for bypass mode is no output after UPS is connecting mains power and breaker is turned on. This can be configurable.***

### 3.5 Test function:

ONLINE and ECO mode press the key for more than 4s, the UPS will

enter the battery self-test mode, and the battery self-test mode will automatically detect whether the battery is connected normally or whether the battery voltage is low. After this the UPS will return to ONLINE mode .

### 3.6 Turn off the UPS:

#### (1) In ONLINE Mode:

Press ON/OFF button continuously for more than 500ms to turn off the UPS, the UPS will get into no output or bypass mode. In circumstance, the UPS might have output power if bypass mode is enabled. Disconnect the mains power to turn off the output.

#### (2) In Battery Mode:

Press ON/OFF button continuously for more than 500ms to turn off the UPS, the UPS will get into no output or standby mode. After 10s UPS will be shut down completely.

### 3.7 Audible alarm mute function:

If the audio alarm is too annoying in battery mode, the audio alarm is able to mute by press Test/Silence button continuously for more than 2s and less than 4s, the UPS can quiet the current alarm sound (including battery mode or bypass mode). Press this button again for more than 2s and less than 4s. Mute is released and the buzzer returns to normal. Note: the buzzer is only the sound of the current alarm, the buzzer will re-beep when a new alarm appears.

**Alarm Table List**

NO.	Status	Alarm
1	Battery mode	Beep once every 4 sec
2	Battery mode with battery low	Beep once every sec
3	Bypass mode	Beep once every 2 min
4	Overload	Beep twice every sec
5	Warning active (see Warning& Fault Code Table )	Beep once every sec
6	Fault active	Beep continuously
7	Button function active	Beep once

## 4. Operating Mode

The different string could be displayed on the LCD screen corresponding to their operating modes, and they are illustrated as the following table. At any time, only one normal operating string or fault string is presented. But the warning, even several warnings could appear in a certain normal operating mode at one time. And the normal operating mode string and the warning string would be shown circularly. Once one fault is come forth, then all previous warnings would not be shown again but only the fault string is presented.

**Warning& Fault Code Table 4.1**

Event Name	Event Code	Alarm Type	Audible
Site Fault	04	Warning	Beep once/1s
Battery Open	11	Warning	Beep once/1s
Battery Low	12	Warning	Beep once/1s
Over Charge	14	Warning	Beep once/1s
Charger Failure	15	Warning	Beep once/1s
Inner Temperature High	8E	Warning	Beep Continuous
External Charger Failure	1E	Warning	Beep once/1s
Output overload	41	Warning	Beep twice/1s
Fan LOCK	85	Warning	Beep once/1s
Heat sink Over Warn	86	Warning	Beep once/1s
Battery Connect Error	1F	Fault	Beep Continuous
BUS over voltage	21	Fault	Beep Continuous
BUS under	22	Fault	Beep Continuous
BUS Short	24	Fault	Beep Continuous
Bus Softstart Fail	25	Fault	Beep Continuous
Output short circuit	31	Fault	Beep Continuous
Inverter over volt	32	Fault	Beep Continuous
Inverter under volt	33	Fault	Beep Continuous
Inverter softstart Fail	34	Fault	Beep Continuous
Inverter Cap Open	35	Fault	Beep Continuous
Inverter output overload	42	Fault	Beep Continuous
Heat sink Over Temperature	81	Fault	Beep Continuous
Heat sink NTC Abnormal	87	Fault	Beep Continuous

### 4.1 ONLINE MODE

The LCD display in ONLINE mode is shown as figure 4.1. The information about the mains power, the battery level, the UPS output and the load level

will be displayed .

Note : Press Test/Silence button to switch page.

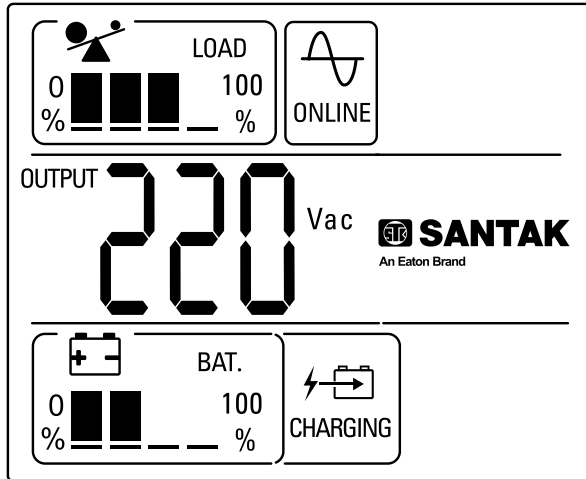

■ Figure 4.1 The Line mode

## 4.2 BAT. MODE

The LCD display in BAT. mode is shown as figure 4.2. The information about the battery voltage, the battery level, the UPS output and the load level will be displayed.

When the UPS is running in battery mode, the buzzer beeps once every 4 seconds. If the “Test/Silence” button on the front panel is pressed for more than 2s and less than 4s, the buzzer will stop beeping (in silence mode). Press the “Test/Silence” button once again for more than 2s and less than 4s to resume the alarm function.

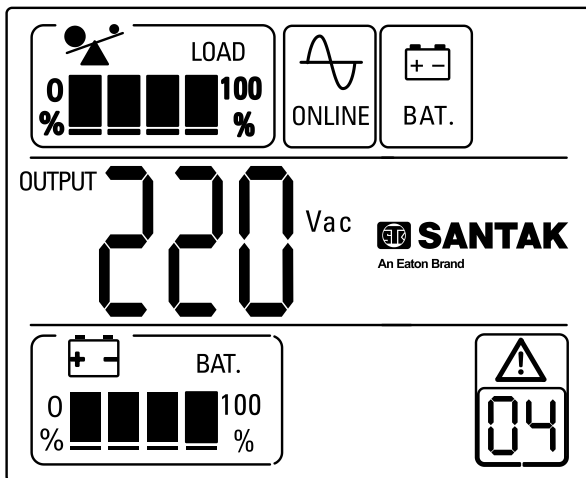

■ Figure 4.2 The Battery mode

### 4.3 BYPASS MODE

The LCD display in bypass mode is shown as figure 4.3. The information about the mains power, the battery level, the UPS output and the load level will be displayed. The UPS will beep once every 2 minutes in bypass mode.

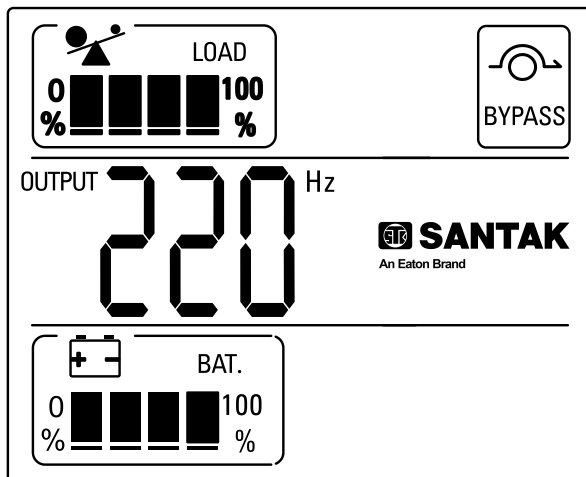

■ Figure 4.3 The Bypass mode



## 4.4 NO OUTPUT MODE

The LCD display in No output mode is shown as figure 4.4. The information about the mains power, the battery level, the UPS output and the load level could be displayed.

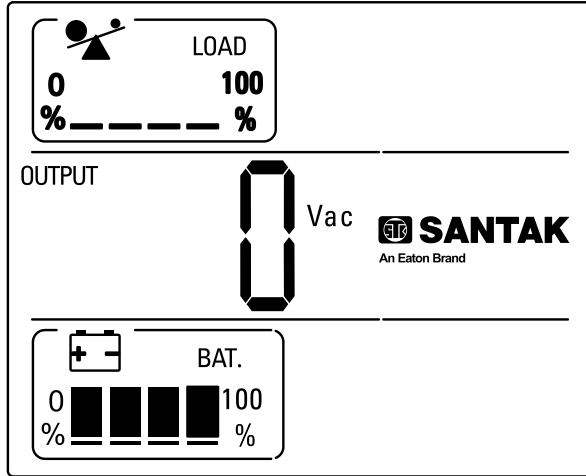

■ Figure 4.4 The No output mode

## 4.5 ECO MODE (ECONOMY MODE)

It is also called high efficiency mode. After turning UPS on in ECO mode, the output power will be supplied from mains power directly via internal filter while the mains power is in certain range, so the high efficiency performance would be gained in ECO mode. Once the mains power is loss or out of range, the UPS will transfer to battery mode and the load will be supplied continuously by the battery.

- 1) ECO mode can be enabled through the software (Winpower, etc.).
- 2) The transfer time of UPS output from ECO mode to battery mode is less than 10ms. It is suggested that takes account of application for some sensitive load.

## 4.6 CVCF MODE

CVCF (Constant Voltage Constant Frequency) which is also called

converter mode, UPS would works in frequency free-run with fixed output frequency (50Hz or 60Hz). Once the mains are loss or abnormal, the UPS would transfer to battery mode and the load is supplied continuously by the battery.

- 1) CVCF mode can be enabled through the software (Winpower, etc.).
- 2) The normal power rating will be derating to 60% in converter mode.

## 5. Trouble Shooting

If the UPS system does not operate correctly, check the operating status on the LCD display. The Warning code or fault code is shown in Warning& Fault Code Table 4.1

If the UPS system does not operate correctly, please attempt to solve the problem using the table below.

<b>Warning &amp; Fault Code</b>	<b>Problem</b>	<b>Possible cause</b>	<b>Remedy</b>
/	No indication, no warning tone even though system is connected to mains power supply	1) No input voltage 2) Breaker open	1) Check building wiring socket outlet and input cable. 2) Check the Breaker
/	No Communication data	1) RS232 wire is not matched 2) USB wire is not matched	1) check or change the RS232 wire 2) check or change the USB wire
/	Emergency supply period shorter than nominal value	1) Batteries not fully charged 2) Batteries defect	1) Charge the batteries until the Batteries are fully charged 2) Change the batteries or consult your dealer.
85	Fan fail	Fan abnormal	Check if the fan is running
86	Heat sink over warn	Heat sink temperature high	1)Check if the air intake and air outtake is blocked; 2) The ambient temperature is too high

1F	Battery Connect Error	Battery Connect Error	Check the connects of battery
14	Battery over voltage	Battery is over charged	Switching to battery mode automatically, and after the battery voltage is normal and the mains is normal, the UPS would Switch to line mode automatically again.
12	Battery low	Battery voltage is low	When audible alarm sounding every second, battery is almost empty.
11	Battery open	Battery pack is not connected correctly	Do the battery test to confirm. Check the battery bank is connected to the UPS. Check the battery breaker is turn on.
15	Charge fail	The charge is broken	Notify dealer.
1E	External Charger Failure	The charge is broken	Notify dealer.
21	Bus high	UPS internal fault	Notify dealer
22	Bus low	UPS internal fault	Notify dealer
25	Bus soft start fail	UPS internal fault	Notify dealer
24	Bus short	UPS internal fault	Notify dealer
81	Inverter temperature high	Inside temperature of the UPS is too high	Check the ventilation of the UPS, check the ambient temperature.
8E	Inner Ambient temperature high	The ambient temperature is too high	Check the environment ventilation.
32	Inverter high	UPS internal fault	Notify dealer

33	Inverter low	UPS internal fault	Notify dealer
34	Inverter soft start fail	UPS internal fault	Notify dealer
87	Inverter NTC Abnormal	UPS internal fault	Notify dealer
31	Output short circuit	Output short circuit	Remove all the loads. Turn off the UPS. Check whether the output of UPS and loads is short circuit. Make sure the short circuit is removed, and the UPS has no internal faults before turning on again.
41	Overload	Overload	Check the loads and remove some non-critical loads. Check whether some loads are failed.
04	Site fail	Phase and neutral conductor at input of UPS system are reversed	Rotate mains power socket by 180° or connect UPS system.

Please have the following information at hand before calling the After-Sales Service Department:

1. Model number, serial number
2. Date on which the problem occurred
3. LCD display status, Buzzer alarm status
4. Mains power condition, load type and capacity, environment temperature, ventilation condition
5. The information (battery capacity, quantity) of external battery pack
6. Other information for complete description of the problem

## **6. Maintenance**

### **6.1 Operation**

The UPS system contains no user-serviceable parts.

### **6.2 Storage**

If the batteries are stored in temperate climatic zones, it is recommended to recharge those batteries every three months for 1~2 hours. It is highly suggested to shorten the recharging intervals in every two months at locations where subjects to high temperatures.

## 7. Technical Data

### 7.1 Electrical specifications

INPUT						
Model No.	Castle 1K	Castle 1KS	Castle 2K	Castle 2KS	Castle 3K	Castle 3KS
Phase	Single					
Frequency	40~70 Hz					
Current(A)	220/230/240 VAC	220/230/240 VAC	220/230/240 VAC	220/230/240 VAC	220/230/240 VAC	220/230/240 VAC
	4.9/4.7/4.5A	5.7/5.4/5.2A	9.7/9.3/8.9A	9.7/9.3/8.9A	14.5/13.9/ 13.3A	14.5/13.9/ 13.3A

OUTPUT			
Model No.	Castle 1K/1KS	Castle 2K/2S	Castle 3K/3KS
Power rating*	1kVA/0.9kW	2kVA/1.8kW	3kVA/2.7kW
Voltage	220Vac/230Vac/240Vac		
Frequency	50/60Hz		
Wave form	sinusoidal		

**\*Note: the active power is defined in rated voltage input**

BATTERIES						
Model No.	C1K	C1KS	C2K	C2KS	C3K	C3KS
Voltage	24V	24V	48V	48V	72V	72V
Capacity	9Ah	5Ah~120Ah*	9Ah	5Ah~120Ah*	9Ah	5Ah~120Ah*

\*Note : the Capacity of external batteries can be set to 300Ah maximum but it may need more time to fully charge the batteries. C = Castle

### 7.2 Operating Environment

Ambient Temperature	0°C to 40°C
Operating humidity	< 95%
Altitude	< 1000m <sup>(Note 1)</sup>
	1000m < Altitude ≤ 3000m <sup>(Note 2)</sup>
Storage temperature	-25°C~55°C

Note 1: the load no derating

Note 2: the load should derating 1 % for every up 100m

### 7.3 Typical backup time (Typical values at 25°C in minutes :)

Model No.	100 % Load	50 % Load
Castle 1K	3'30"	10'30"
Castle 1KS	Depend on the external battery	
Castle 2K	3'30"	10'30"
Castle 2KS	Depend on the external battery	
Castle 3K	4'00"	11'30"
Castle 3KS	Depend on the external battery	

### 7.4 Dimensions and weights

Model No.	Dimensions W×H×D (mm)	Net Weight (kg)
Castle 1K	144*228*356	9.2Kg
Castle 1KS	102*228*346	3.9Kg
Castle 2K	190*327*399	17.4Kg
Castle 2KS	102*327*390	6.4Kg
Castle 3K	190*327*399	22.7Kg
Castle 3KS	102*327*390	6.4Kg



## **8. Communication Port**

On the rear panel of the UPS (see Appendix), RS232 connector and Slot for optional connectivity cards are standard.

### **8.1 RS-232 Communication Ports**

To establish communication between the UPS and a computer by use an appropriate communication cable.

### **8.2 AS400 Interface (Optional)**

It owns isolated dry contact relay outputs for UPS status: such as Mains/Utility failure, Battery low, UPS alarm/OK, or on Bypass and so on. More detail about the interface definitions please read the AS400 user manual.

### **8.3 CMC Interface (Optional)**

It provides connection to Modbus protocol with standard RS485 signal.

More detail please read the CMC user manual.

### **8.4 NMC Interface (Optional)**

NMC (Network Management Card) allows the UPS to communicate in a variety of networking environments and with different types of devices. NMC achieves a remote management for the UPS through internet/intranet. Please contact your local dealer for further information. More detail please read the NMC user manual .

## **8.5 Software**

### **Free Software Download – WinPower**

WinPower is brand new UPS monitoring software, which provides user-friendly interface to monitor and control your UPS. This unique software provides safely auto shutdown for multi-computer systems while

power failure. With this software, users can monitor and control any UPS on the same LAN no matter how far from the UPSs.

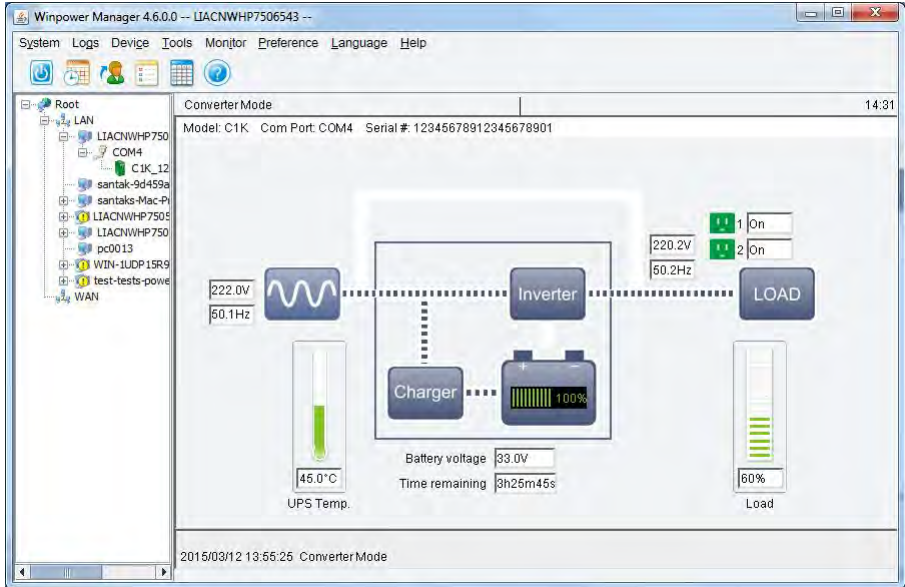

### Installation procedure:

1. Go to the website:  
<http://www.santak.com>  
click "Product" → click "System Monitoring".
2. Choose the operation system you need and follow the instruction described on the website to download the software.

When your computer restarts, the WinPower software will appear as a green plug icon located in the system tray, near the clock.

## Appendix : Rear panel

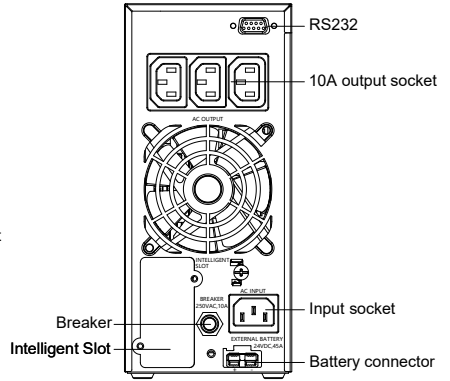
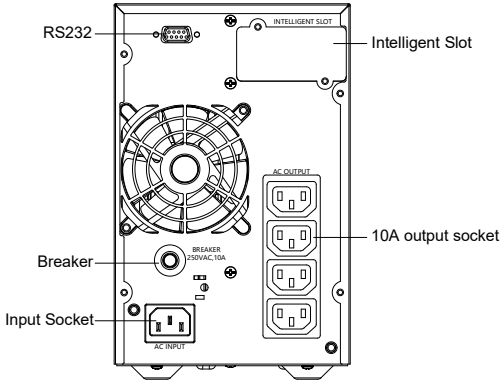

### 1K(S) Back View

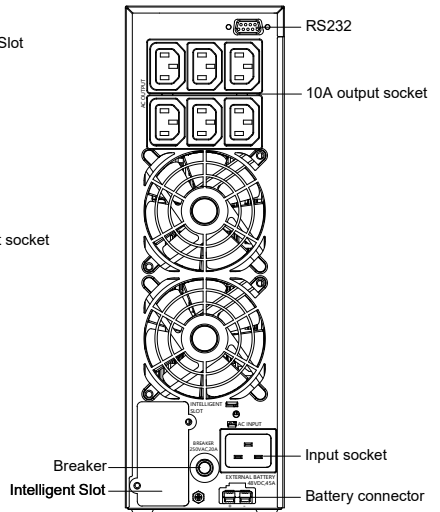
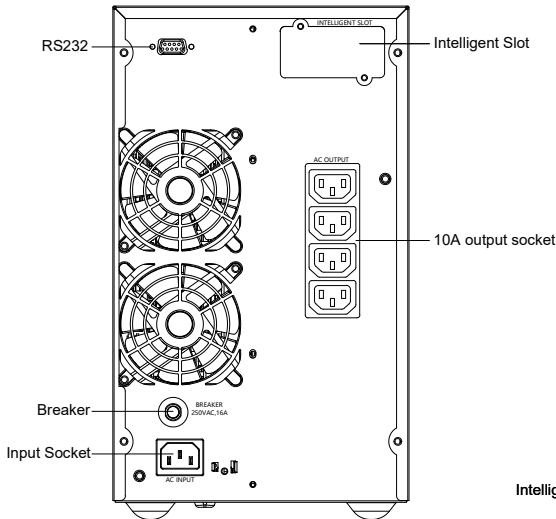

## 2K(S) Back View

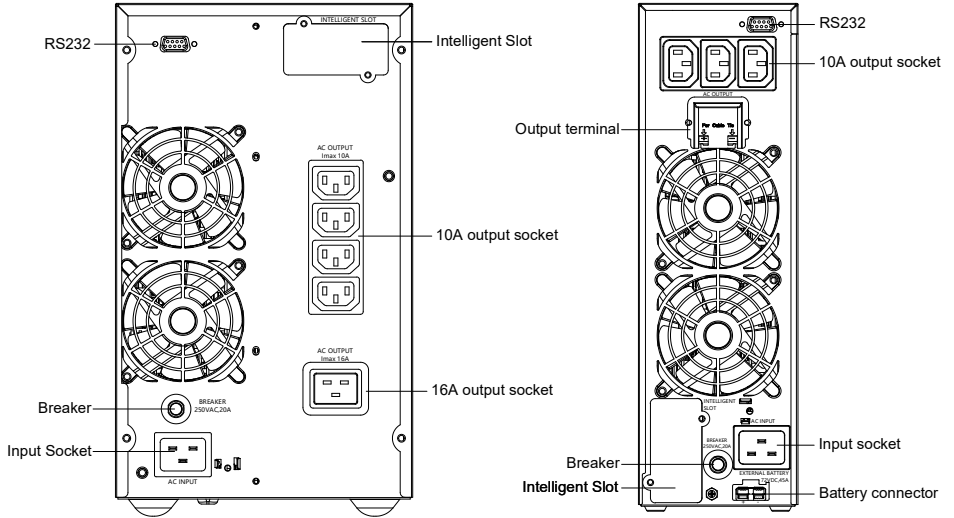

## 3K(S) Back View



**SANTAK ELECTRONIC (SHENZHEN) CO.,LTD**

---

No.8 Baoshi Rd, Block 72 Baoan, Shenzhen,  
Guangdong, China

[www.eaton.com](http://www.eaton.com)    [www.santak.com](http://www.santak.com)

614-02071XS1-02